

TMF 35-28-4

Asynchronous Motor for Medium Duty Applications

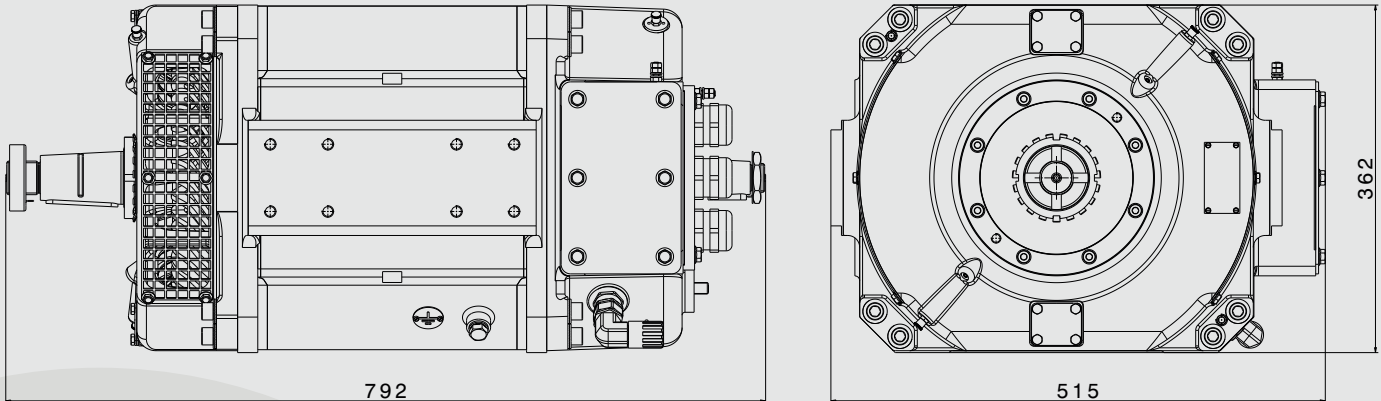

Technical Data

Motor

DC link voltage	600 - 900 V
Max. speed	4800 rpm
Power (peak 1 min continuous 30 min)	276 212 kW
Torque (peak 1 min continuous 30 min)	1800 1100 Nm

Total weight	350 kg
Protection class	IP20 IP65 (ISO 20653) (traction motor terminal box)
Cooling system	Air-cooled, forced ventilated

Different winding design possible.

Looking for an electric drive system?

This motor can be delivered as part of a complete electric drive solution thanks to strategic partnerships.

Your advantages at a glance

- * noise-optimized system
- * high-end-insulation system class R (220 °C)
- * made in Europe
- * can meet Buy America requirements
- * longlife bearing concept
- * operation with various inverter types possible
- * proven and robust technology
- * Rare earth element (REE) free
- * Long-Life Value Service

Contact us! Headquarters Austria

✉ road@tsa.at
www.tsa.at/road



Traktionssysteme Austria GmbH
Brown-Boveri-Str. 1
2351 Wiener Neudorf
Austria

